

GSM/GPRS/GPS Vehicle Tracker

GPS103-A/GPS103-B User Manual



Preface

Thank you for purchasing the tracker. This manual shows how to operate the device smoothly and correctly. Make sure to read this manual carefully before using this product. Please note that specification and information are subject to changes without prior notice in this manual.

Any change will be integrated in the latest release. The manufacturer assumes no responsibility for any errors or omissions in this document.

Contents

1. Function Introduction.....	4
2. Applications	4
3. Hardware Description	4
4. Accessories Name	6
5. Specifications	7
6. Operating Instructions	8
6.1 Terminal Installation	8
6.4 GSM/GPS LED Indicator	10
6.5 Initialization	10
6.6 Change Password	10
6.7 Authorization.....	11
6.8 Single Locating	12
6.9 Successive Locating Automatically	12
6.10 Get location in real street/address name	13
6.11 Monitor.....	13
6.12 Modes switch between “track” & “monitor”	13
6.13. Alarms	14
6.13.1 Low battery alarm	14
6.13.2 Power off alarm.....	14
6.13.3 SOS.....	14
6.13.5 Movement alarm	15
6.13.6 Overspeed alarm.....	15
6.14 Cut off the Oil and Power System	16
6.15 Resume the Oil and Power System	16
6.16 Arm.....	16
6.17 Disarm	17
6.18 Function of Remote Control (Option, for model B ONLY)	18
6.19. Alarms under Arm State	18
6.19.1 door alarm	18
6.19.2 Sensor alarm.....	18
6.19.3 ACC alarm	19
6.20. Silent Mode	19
6.21. No GSM Network Alarm	20
6.22 Check the Vehicle State.	20
6.23 Tracker’s Hardware Resetting	21
6.24 IMEI Checking.....	21
6.25 Time Setting	21
6.26 GPRS Setting	21
6.27 Setting up APN	22
6.28 GPRS User Name and password Setup	22
6.29 IP and Port Setup.....	23

6.30. Modes Switch between “SMS” and “GPRS”	23
6.31 User manual of web based and PC installation monitor software	23
7. Cautions.....	23
8. Faults & the Solutions.....	24

1. Function Introduction

1.1 This tracker is a new product based on the GSM / GPRS network and GPS satellite positioning system, which set multiple functions of security, positioning, monitoring surveillance, emergency alarms and tracking in its entirety. It can track and monitor remote target by SMS or internet.

1.2 Features

1.2.1 Support both GPS / GSM station positioning ways.

1.2.2 Support SMS/GPRS/Internet Network data transmission
(GPRS/Internet instructions in CD enclosed)

1.2.3 Support GPRS on-line and GPRS re-connected automatically if GPRS drops

1.2.4 Support SMS / GPRS dual-mode switching

1.2.5 Support configuration by remote terminal.

1.2.6 Support for point-to-point, point to group, group-to-group monitoring.

1.2.7 Set multiple functions of security, positioning, monitoring surveillance, emergency alarms and tracking in its entirety.

2. Applications

Used widely for vehicle and other moving objects tracking.

3. Hardware Description

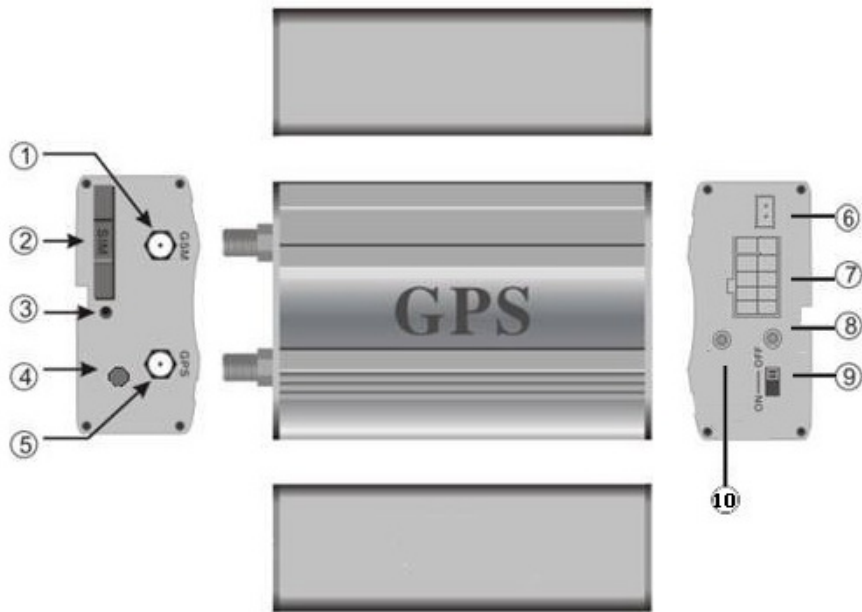

①. GSM Antenna jack

②. SIM card slot

③. SIM card slot Pop-up switch

④. Monitor jack

⑤. GPS Antenna jack

⑥. Sensor jack

⑦. External Connection jack









⑧. Power/GSM/GPS LED indicator

⑨. Backup battery switch

⑩. Remote control receiver antenna

(Option, For model B only)

4. Accessories Name

NO.	PHOTOES	NAME	NOTE
1		GPS Antenna	3 meters
2		GSM Antenna	3 meters
3		Microphone	1.5 meters
4		Harness	10PIN
5		Relay	12V/40A to 24V/40A according to vehicle model
6		Shake sensor	Option for both model A and B
7		Siren	Option for model B ONLY
8		Remote control	Option for model B ONLY

5. Specifications

Content	specifications
DIM.	83*54*26mm
Weight	120g
Network	GSM/GPRS
Band	850/900/1800/1900Mhz or 900/1800/1900Mhz
GSM/GPRS Module	Simcom900B
GPS Module	SIRF3 chip
GPS Sensitivity	-159dBm
GPS Accuracy	5m
GPS Start time	Cold status 45s Warm status 35s Hot status 1s
Voltage of car power system	12 V -24V
Backup battery	Chargeable changeable 3.7V 800mAh Li-ion battery
Storage Temp.	-40°C to +85°C
Operation Temp.	-20°C to +65°C
Humidity	5%--95% non-condensing

6. Operating Instructions

6.1 TERMINAL INSTALLATION

6.1.1 Please ask the qualified engineers to install it.

6.1.2 Do not install it in a environment which is more than GSM performance, And please pay attention to fix the antennas in a exactly position with good signals.

6.1.3 Pay attention to make installation location preventing water and dust.

6.1.4 Find the 10 PIN harness and insert it into the corresponding holes of the products, and connect the wires with the original car circuit showing below:

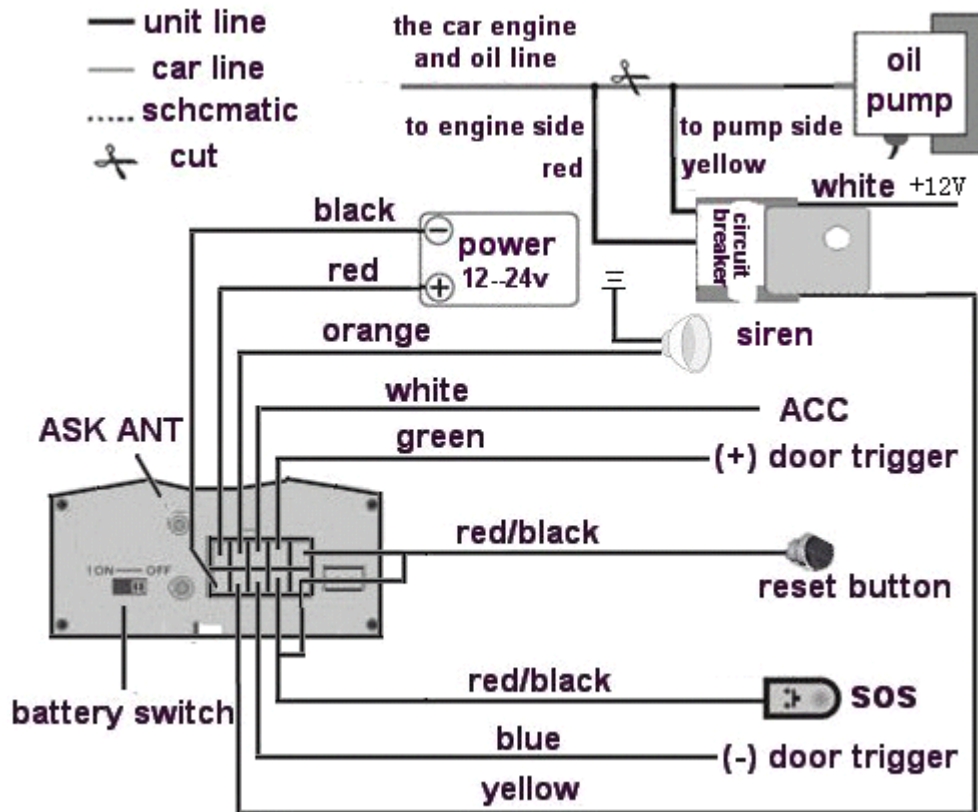

Wiring diagram

6.1.5 Note: The orange wire can be connected to the original car alarm horn; it can also be connected to the siren you buy with the tracker. (Siren is Option)

6.1.6 Knowing about the type of the door trigger is positive or negative trigger.

Please connect the green wire to the door control circuit if it is positive, and connect blue wire if it is negative.

6.1.7 Please install the Reset button and SOS button on the place driver can touch.

6.1.8 Insert the shake sensor plug into the sensor jack. (Shake sensor is Option)

6.1.9 Insert the external monitor Microphone into the monitor jack.

6.1.10 Connected the GPS and GSM antenna to the right jack, and find a appropriate place and fix the antennas to make sure it receive signals very well.

6.2 SIM CARD INSTALLATIONS

6.2.1 Use a tweezers or a sharp thing to touch the SIM CARD popup switch, the SIM CARD slot will pop up, take out the SIM card slot and put SIM card in it. And then put the SIM card slot back to its original position after confirm the SIM card in the right place.

6.2.2 Please make sure that the SIM card is able to execute the function of incoming calls display, no calls can be diverted and the PIN code is locked. The SMS format must be TXT format, and can't recognize the PDU format.

6.3 Turn on the Tracker Device.

6.3.1 Connect the positive and negative wire, red and black ones, with 12V or 24V car power system, wait for 1 minute after connecting power to wait tracker works normal, and then turn on the backup battery switch.

6.4 GSM/GPS LED Indicator

6.4.1 Red LED indicator on: No GSM network signals.

6.4.2 Red LED indicator flash fast (one time each second): GSM Network signal is normally, and tracker works under GSM mode.

6.4.3 Red LED indicator flashes slowly (one time each three second): Tracker works under GPRS mode.

6.4.4 Green LED indicator on: GPS signal is normal.

6.4.5 Green LED indicator off: No GPS signals.

6.5 Initialization

Send SMS “begin+password” to the unit, it will reply “begin OK” and initialize all the settings to default factory settings. (default password: 123456)

For example: send SMS “begin123456”, it will reply “begin ok”. (No quotation marks” ” when sending all the SMS)

6.6 Change Password

6.6.1 Send SMS “ password+old password+space+new password” to the unit to change the password.

For example: send SMS “password123456 888888” to the unit. If succeeded, “password OK” will reply to your cell phone from the device tracker.

6.6.2 Be sure to keep the new password in mind, you have to upload the

software to restore the original setting in case of losing the new password.

6.63 Attention: Make sure the new password is in 6 digits, or else the tracker cannot recognize the password.

6.6.4 **The “+” in the command, please don’t type “+”, space means press the space keyboard on your cell phone.**

6.7 Authorization

There are 5 numbers to be allowed to authorize in the tracker at most.

6.7.1 Call and track the tracker device for 10 times from cell phone in success, it will make the cell phone number as the authorized number automatically, and reply “add master ok”.

6.7.2 Authorization: Send SMS “admin+password+space+cell phone number” to set up an authorized number, the other authorized numbers should be set by the first authorized number, if the number is successfully authorized, the unit will reply” admin OK” by SMS.

6.7.3 Delete authorization: Send SMS” noadmin+password+space+authorized number” to delete the authorized number.

6.7.4 If you want to track the target tracker device when it enters into another country, you must add the country code before the cell phone number, for example, send SMS” admin123456 008613322221111” to the device.

Note: 13322221111 will be set up as the authorized number.

6.8 Single Locating

6.8.1 Any number call the tracker device, it will reply a SMS including the position of latitude and longitude if don't set up the authorized number. If authorized number has set successfully, the device won't reply SMS including the positioning of latitude and longitude when the unauthorized number dials up it.

6.8.2 Dialing the tracker device from the authorized number, it will hang up your calling and respond to a real-time latitude and longitude information as following:

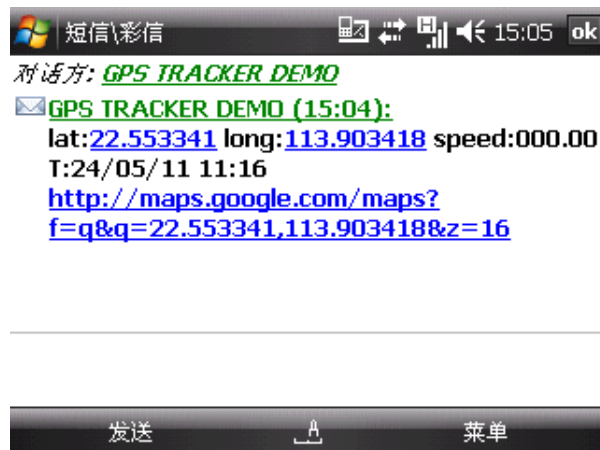

6.8.3 When GPS signals lost, The SMS including the position of latitude and longitude is the positioning that the tracker received GPS signals at last. It is different with its exact current location, so you should pay attention to the time included in the SMS you got.

6.9 Successive Locating Automatically

6.9.1 Send SMS command “fix030s005n +password” to the tracker device, it will report the Geo-info at 30s intervals for 5 times. (s:second, m:minute,

h:hour). This command set must be in 3 digits and the maximum value is 255.

6.9.2 Send SMS “fix030s***n+password” to the tracker device, it will reply the Geo-info continuously at 30 seconds intervals.

6.9.3 Cancellation: Send SMS “nofix+password” to the tracker device to cancel the “auto track”.

Note: the interval must not less than 20s.

6.10 Get location in real street/address name

6.10.1 You must set up the APN of your local GSM network for the SIM card in tracker first before using this function, if there is user name and password for GPRS login, Please refer to 6.27 and 6.28 to configure the APN, user name and password for GPRS login.

6.10.2 After configure the APN, send address+password to device, it will reply SMS including real street/address name. For example: No.113, Nantou Guankou 2nd Rd. Nanshan district, Shenzhen, Guangdong, china.

6.11 Monitor

In this mode, the user can dial up the tracker device to monitor the voice (please refer to 6.12 for instruction).

6.12 Modes switch between “track” & “monitor”

6.12.1 The default mode is “track” (track mode).

6.12.2 Send SMS command "monitor+password" to tracker device of vehicle terminal, it will reply "monitor ok!" and switch to “monitor” mode.

6.12.3 Send SMS command "tracker+password" to tracker device of vehicle terminal, It will return "tracker ok!" and restore to “track” mode.

6.13. Alarms

6.13.1 LOW BATTERY ALARM

When the voltage of the tracker device is near 3.6V, it will send SMS “low battery+lat./long information to the authorized number in 3 minutes interval.

6.13.2 POWER OFF ALARM

When the power be cut off or the voltage is 0V, the tracker device will send SMS “power alarm+lat./long. to the authorized number in 3 minutes interval.

6.13.3 SOS

Long Press the SOS button for 3 seconds, the tracker device will send SMS “help me!+lat./long. to all the authorized numbers in 3 minutes interval. It will stop sending such a SMS when any authorized number reply SMS “help me!” to the tracker.

6.13.4 Geo-fence

Set up a geo-fence for the tracker device to restrict its movements within a district. The unit will send SMS to the authorized numbers when it goes out of this district.

Set up: When the unit stays immobile in a place for 3-10 minutes, the user can send SMS “stockade+password+space+latitude,longitude;latitude,longitude” to unit to set the restricted district. In case of breach, it will send SMS “stockade!+geo-info” to the authorized numbers.

Remark: The first latitude & longitude is coordinate of the top left corner of the Geo-fence, while the second latitude & longitude is the coordinate of the bottom right corner, it will alarm in 3 minutes interval.

Cancel: Send SMS “nostockade+password” to deactivate this function.

6.13.5 MOVEMENT ALARM

Set up: when the unit stays immobile in a place for 3-10 minutes, the user can send SMS “move+password” to the tracker device. It will reply “move OK”. In case of such a movement (the default distance is 200m), it will send SMS “Move” along with a Geo-info to the authorized numbers, it will alarm in 3 minute interval.

Cancel: Send SMS “nomove+password” to deactivate the movement alarm.

6.13.6 OVERSPEED ALARM

Set up: Send SMS “speed+password+space+080” to the unit(suppose the speed is 80km/h),and it will reply “speed OK!”.When the target moves exceeding 80km/h.the unit will send SMS “speed+080!+Geo-info” to the authorized

numbers. It will alarm one time in 3m interval.

Cancel: Send SMS “nospeed+password” to deactivate the overspeed alarm.

Remark: It is recommended that the speed alarm is set at not less than 30km/h. For below that rate; it may cause the excursion of the GPS signal influenced by clouds etc.

6.14 Cut off the Oil and Power System

Send SMS command “stop+password” to the tracker device, it will reply “Stop engine Succeed” to your cell phone from the tracker device, and stop your car engine as well, at the same time. It will remain the immobile state until receiving the next SMS command of resuming the oil and power once receiving SMS command to cut off the oil and power system.

6.15 Resume the Oil and Power System

Send SMS command “resume+password” to the unit, It will reply “Resume engine Succeed” and resume your car engine as well, at the same time. It will remain this state until receiving the next SMS command to cut off the oil and power system once receiving SMS command to resume the oil and gas system.

6.16 Arm

6.16.1 Set up arm by SMS

Send SMS command “arm+password” to the tracker device in the vehicle. It will reply “Tracker is activated” in both armed and disarmed state, and the SMS command will make the tracker device enter into armed state if the unit currently disarmed.

User must stop the engine, (that is ACC is lower voltage). Sending SMS “arm+password” when close the door and left. You will set up arm status fail if the engine is turned on (the ACC is high voltage), it will reply “set up fail! pls turn off ACC”

6.16.2 Set up arm by remote control (Option, for model B ONLY)

Press “A” button on the remote control, the car enters into armed state and the siren will alarm one time, no SMS reply.

6.17 Disarm

6.17.1 Disarm by SMS

Send SMS command "disarm + password" to the tracker device in the vehicle, It will reply “Tracker is deactivated” in both armed and disarmed state, and the SMS command will make the tracker device enter into disarmed state if the unit currently armed.

It won't alarm if the door is open and sensor is vibrated and the engine is started when deactivated this arm function.

6.17.2 Disarm by remote control (Option, for model B ONLY)

Press “B” button on the remote control, the car enters into disarm state, and the siren will alarm two times, no SMS reply.

6.18 Function of Remote Control (Option, for model B ONLY)

ARM Press “A” button for 0.5 second, the siren will alarm one time.

DISARM Press “B” button for .5 second, the siren will alarm two times.

Silent mode Press “A+B” together for 0.5 second when it is in disarm state, the siren will alarm three times.

Quit silent mode Press “A+B” together for 0.5 second again when it is in disarm state, the siren will alarm four times.

Deterrence Long press “A” button for 3 seconds, siren will alarm for 10 seconds, press “A” or “B” button to quit

6.19. Alarms under Arm State

6.19.1 DOOR ALARM

The unit will send SMS “Door alarm+lat/long” to the authorized number in 3 minutes interval when the door of the car opens in arm status; Siren will alarm for 30 seconds in every 1 minute interval, send “disarm+password” to stop it.

6.19.2 SENSOR ALARM

The unit will send SMS “Sensor alarm+lat/long” to the authorized number in 3 minutes interval when the sensor is triggered in arm status; Siren will alarm for 30 seconds in every 1 minute interval, send “disarm+password” to stop it.

6.19.3 ACCALARM

The unit will send SMS “ACC alarm+lat/long” to the authorized number in 3 minute interval when the engine of the car is turned on, that is the key is rotated to ACC.ON position to start the car in arm state; Siren will alarm for 30 seconds in every 1 minute interval, send “disarm+password” to stop it.

6.20. Silent Mode

6.20.1 Set up silent mode by SMS

Send SMS “silent+password” to tracker device, it will reply “silent ok!”. It means tracker device enters into **silent mode**, siren won't alarm after alarm is triggered, but tracker will send alarm SMS to authorized number.

Quit silent mode send SMS “loud+password” to tracker device, it will reply “loud ok!”. It means tracker quit from silent mode, siren will alarm after alarm is triggered, and it will also send SMS alarm to authorized number.

6.20.2 Set up silent mode by remote control (Option, for model B ONLY)

Silent mode Press “A+B” together in disarm state for 0.5 second, the siren will alarm three time, siren won't alarm after alarm is triggered, but tracker will send alarm SMS to authorized number.

Quite silent mode Press “A+B” together in disarm state for 0.5 second again, siren will alarm four times. Siren will alarm after alarm is triggered. And tracker will also send SMS alarm to authorized number.

6.21. No GSM Network Alarm

When the car is in the place without GSM network service, siren will alarm under non-silent mode if alarm is triggered(door, sensor, ACC), but no SMS alarm will send to authorized number.

6.22 Check the Vehicle State.

Send SMS command “check+password” to the tracker device in the vehicle, It will reply the status of the power, battery, GPS, ACC, door, GSM signal to the authorized number. For example: Send SMS “check123456” to the tracker device in the vehicle, It will reply following SMS.

Power: ON

Battery: HIGH

GPS: OK

ACC: Off

Door: Off

GSM Signal: 1-32(performance). Note: The higher digit it shows; the stronger of GSM signals it receives.

6.23 Tracker's Hardware Resetting

6.23.1 SMS Reset

Send SMS "reset+password" to tracker device to reset the GSM module and GPS module of the tracker device, it will reply "reset ok".

6.23.2 Reset Button Resetting

Press the reset button for 1 second, hardware of tracker device will reset.

6.24 IMEI Checking

Send SMS command "imei+password" to the unit. E.g. Send SMS command "imei123456" to the tracker device, an IMEI number in 15 digits will reply to your cell phone.

6.25 Time Setting

6.25.1 Send SMS command "time+space+zone123456+space+time" to the tracker unit, If succeed, It will reply "time OK"

6.25.2 For example: Send SMS "time zone123456 8", 8 is Chinese time zone, If your country time zone is minus, send SMS "time zone123456 -8".

6.26 GPRS Setting

User must send SMS via cell phone to set up APN, IP and port before starting tracking by GPRS.

6.27 Setting up APN

6.27.1 APN standards for Access Point Name and differs from country to country. For more information about your local APN, please inquire with your local GPRS network operator.

6.27.2 Text the tracker a SMS “APN123456 + Space + your local APN” via a cell phone and if succeeded, the tracker will return the message “APN OK”.

6.27.3 E.g. Send SMS command “APN123456 CMNET”. If succeeded, “APN OK” is returned by the tracker in SMS.

Notes: 123456 refer to password of tracker and CMNET is the APN of one of china GPRS Network Operator (China mobile).

6.28 GPRS User Name and password Setup

6.28.1 In most countries, the user name and password involving GPRS login are not compulsorily necessary, therefore, the entry can be skipped. For those countries requiring user name and password, please configure as following:

6.28.2 Send SMS “up+123456+space+user+space+password”If succeeded, “user, password ok!” is returned by the tracker in SMS.

6.28.3 For instance, send SMS “up123456 jonnes 666666” to the tracker, and if succeeded, the tracker returns “user, password OK”

Note: 123456 is tracker device password, jonnes is the user name for GPRS

login, 666666 is the password for GPRS login.

6.29 IP and Port Setup

6.29.1. Send SMS as below via a cell phone: adminip + 123456 + Space + IP Address + Space + Port Number. If succeeded, “adminip OK” is returned by the device in SMS.

6.29.2 E.g. Send SMS command “adminip123456 202.104.150.75 9000” to the tracker device, If succeeded, “adminip OK” is returned by the device in SMS. (123456 is default password, 202.104.150.75 is IP, 9000 is port).

6.30. Modes Switch between “SMS” and “GPRS”

6.30.1 The default mode is “SMS”

6.30.2 Send SMS “GPRS+password” to the unit, and it will reply “GPRS ok!” it means tracker device has switched to “GPRS” mode.

6.30.3 Send SMS “SMS+password” to the unit, it will reply “SMS ok!” and restore to “SMS” mode.

6.31 User manual of web based and PC installation monitor software includes in the CD in the package box. [Software Platform User Manual]

7. Cautions

Please comply with the instructions to extend the unit life:

1. Keep the unit dry. Any liquid, i.e. rain, moisture, may destroy or damage the inside circuitry.
2. Don't use & store the unit in dusty places.
3. Don't put the unit in overheated or overcooled places.
4. Handle carefully. Don't vibrate or shake it violently.
5. Clear the unit with a piece of dry cloth. Don't clean in chemicals, detergent.
6. Don't paint the unit, this may cause some foreign materials left in between the parts.
7. Don't disassemble or refit the unit.
8. Please read the user manual carefully before installation and operation, learn something more about the voltage range. Otherwise, it won't work properly or destroy the product.

8. Faults & the Solutions

Faults	Solution
Startup Fail	Please check out the power wiring in correct place.
Call Fail	Check the GSM antenna connected. Check whether the
Hang up Fail	In existence of an authorized number, an unauthorized number dials up the unit. Please initialize the unit and

Monitor Fail	Check if the authorized number is setup
Location report in digits of zeros.	Check out if the GPS external antenna well.